

Assembly instructions

PO240 PopUp ARC 4x3 curved double sided



The contents of the package:

- A. Rigid case: 1 piece
- B. PopUp graphic: 10 panels
- C. PopUp frame: 1 piece
- D. Metal bars and textile bag: 30 pieces
- E. Spotlight: 1 piece.

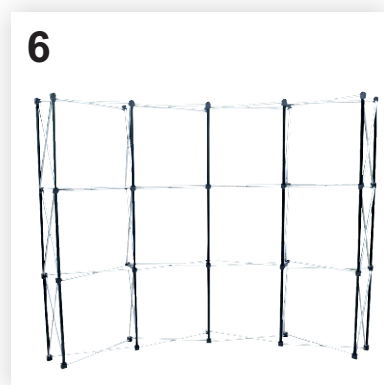
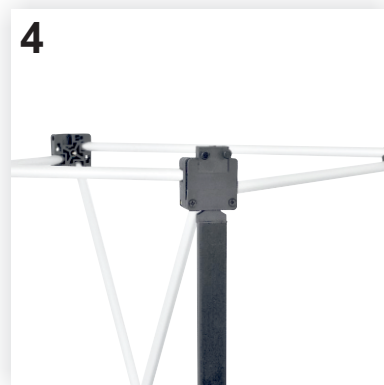
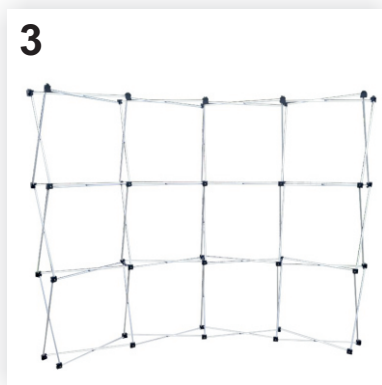
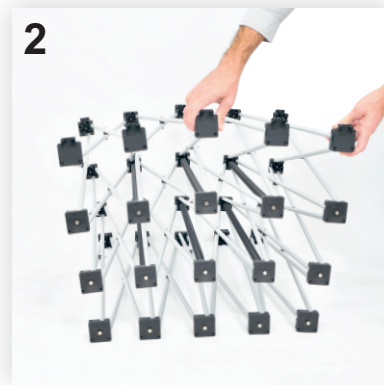

The pictures are for presentation only; your product can be slightly different!

Assembly instructions

PO240 PopUp ARC 4x3 curved double sided



7-8. Hook on the spotlight (E) at the top of the PopUp structure in the left side of the aluminum bars intersection: insert the end of the spotlight support rod provided with grooves, between the two aluminum bars (see the detailed picture). The spotlight can be mounted on top of any of the four columns of the system.

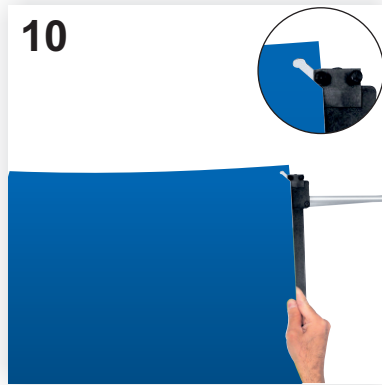

9. Gently take out each graphic panel (B) from the rigid case (A) by rolling it inwards to obtain a small roll. The panels are numbered to facilitate their positioning from left-to-right on the frame.

10. Hang each graphic panel in the pins at the top of the structure, as in the picture. For an easy mounting, it is recommended to start with the middle panel number 3, continue with the central panels at the front 2 and 4 and then attach the central panels at the back 6, 7 and 8.

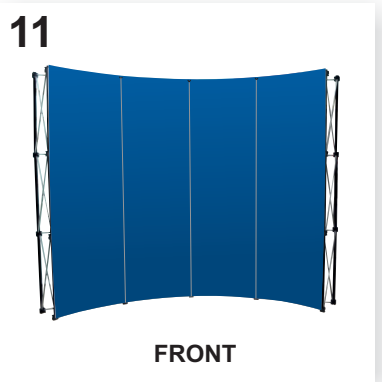

FRONT

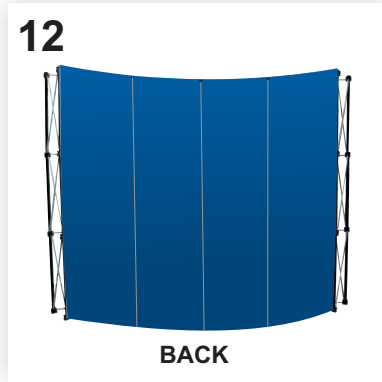

BACK

11-12. Unroll each graphic panel to its full length and attach it to the metal bars. The edge of each panel will be positioned on the middle of the metal bar, the other half remaining free for attaching the next panel. In the curved systems, the panels will have a small inward curvature at the front (see picture 11) and a small outward curvature at the back of the structure (see picture 12).

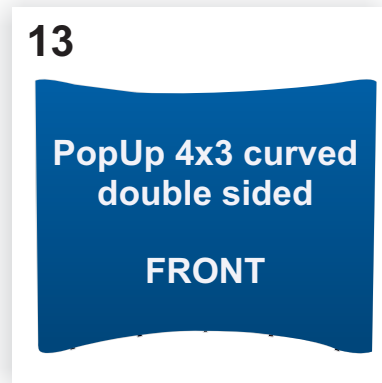

PopUp 4x3 curved double sided

FRONT

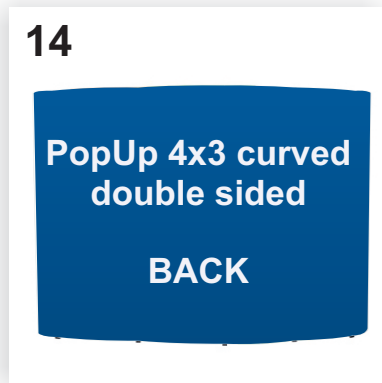

PopUp 4x3 curved double sided

BACK

13-14. After attaching the central panels, you can fix into position the side panels: 1 and 6. Bend the side panels in the shape of a semi-cylinder and hang them with one edge in front and the other behind the frame, to form the sides of the PopUp.

The pictures are for presentation only; your product can be slightly different!